

I-0474

wellneo 

NEW TRENDY Sp. z o.o.

Taszarowo 18

62-100 Wągrowiec

serwis@newtrendy.pl

tel/fax 67 262 12 66

Alvea

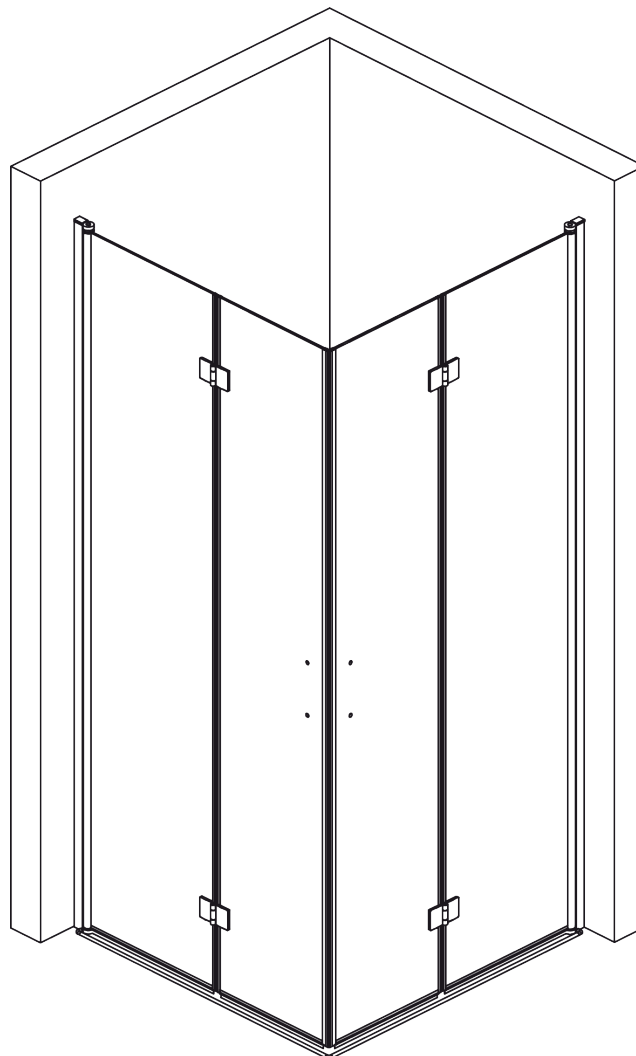

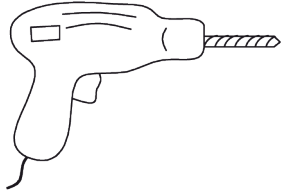
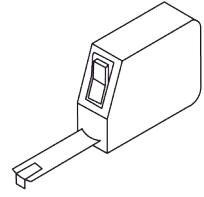
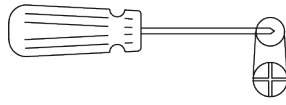
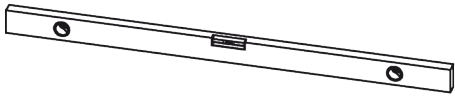



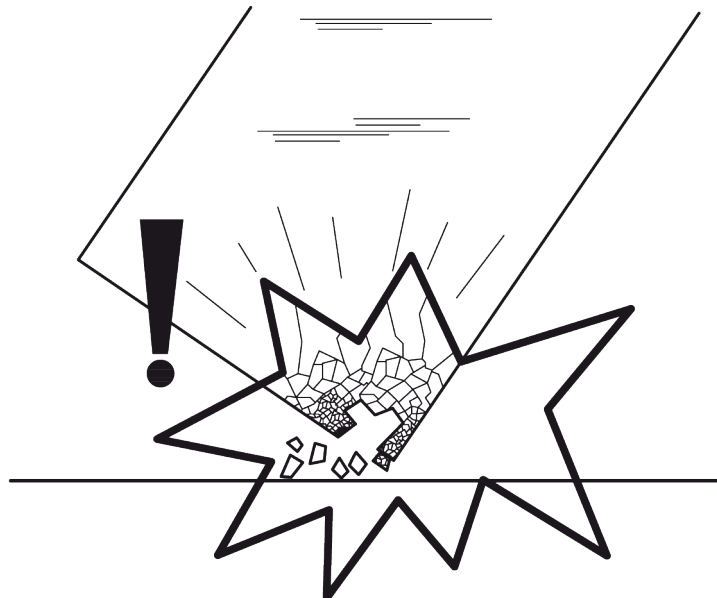
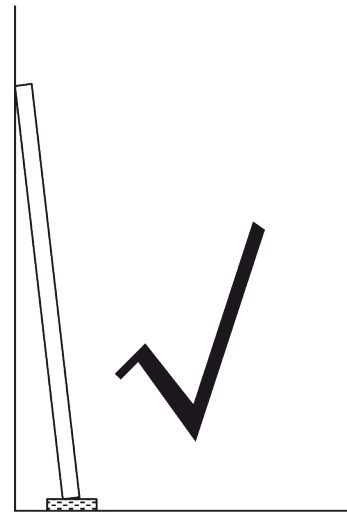
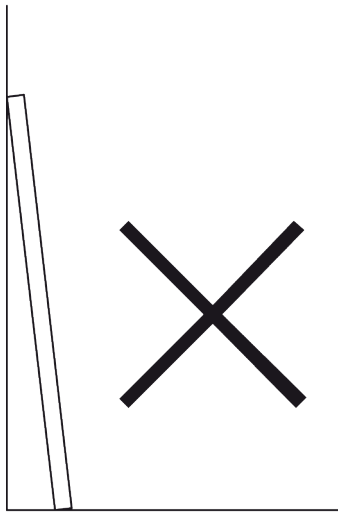
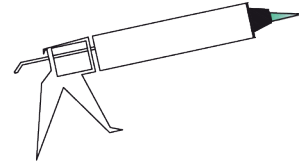

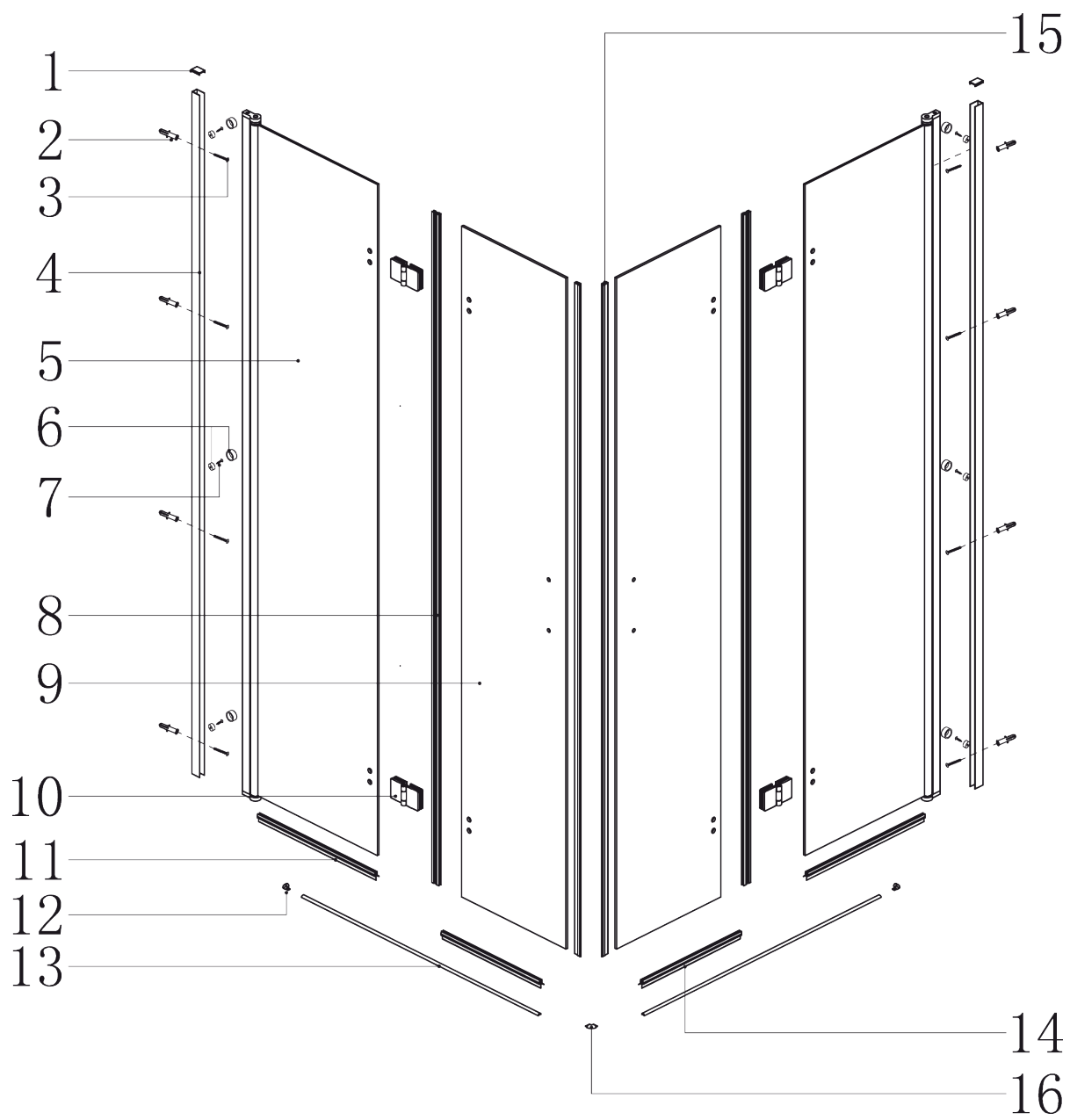









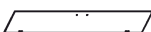



$\phi 6$ $\phi 2.8$





serial number	graphical	name	quantity	remarks
1			2 PCS	
2			8 PCS	
3		ST3. 9X35	8 PCS	
4			2 PCS	
5			2 PCS	
6			6 PCS	
7		ST3. 5X9. 5	6 PCS	
8			2 PCS	
9			2 PCS	
10			4 PCS	
11		L	2 PCS	
12		L/R	2 PCS	
13			2 PCS	
14		S	2 PCS	
15			2 PCS	
16			1 PCS	
17		M4	1 PCS	
18			1 PCS	

WYMIAR / DIMENSIONS	A	B
80	77,2-78,7	77,2-78,7
90	87,5-89	87,2-88,7

